

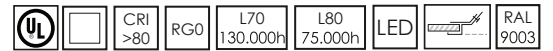

LUNA-LED





Faretto da incasso tondo per qualsiasi tipo di controsoffitto. Anello costruito in lamiera d'acciaio, verniciato con polveri epossipoliestere di colore bianco e antingiallente, con pretrattamento di fosfatazione e sgrassaggio, alimentatore elettronico 230V. Prodotto costruito in conformità alle vigenti norme EN / IEC 60598-1:2015.

Round downlight usable into all false ceilings types. Stainless steel ring, painted with white epoxy polyester powders with phosphate and degreasing pretreatment, electronic ballast 230V. Fitting manufactured according to the EN / IEC 60598-1:2015 rules.

CODIFICA/CODE

Art.	+	Mod.	+	°K	+	W-tot	+	Opt.
6005	+	VS	+	03 = 3000°K	+	09	+	EL = standard
				04 = 4000°K		11		LM = 1-10v
				05 = 5000°K		20		LD = dali
						30		E1 = em-1h
						40		E3 = em-3h
						55		

DIMENSIONI/DIMENSION

	A	B	C	Kg	mc		
D1	125	45	105	0,4	0,006	1	50
D2	180	70	155	0,6	0,006	1	50
D3	240	95	218	1,2	0,010	1	50
D4	240	95	218	1,4	0,010	1	50

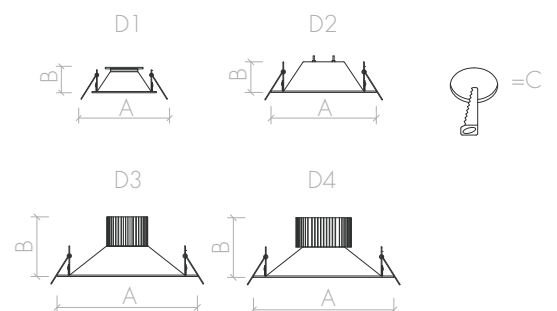

mod/VS

Offiche e diffusori

Riflettore in alluminio metallizzato, vetro sabbato.

Louvers and diffusers

Metallised aluminium reflector, c/ w sanded glass.

- 3000°K = -5.30% lm
- 4000°K = standard
- 5000°K = +0.90% lm

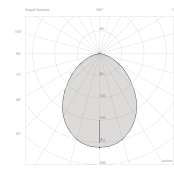

IP40 850° IK07



W-Tot.	Lm (Tc=25°) 4000°K	Lm (Output)	Sost.	Dimension
9	1436	956	100W halog.	D1

mod/VS

Offiche e diffusori

Riflettore in alluminio metallizzato, vetro sabbato.

Louvers and diffusers

Metallised aluminium reflector, c/ w sanded glass.

- 3000°K = -5.30% lm
- 4000°K = standard
- 5000°K = +0.90% lm

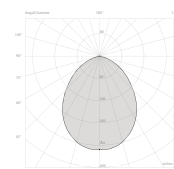

IP40 850° IK07



W-Tot.	Lm (Tc=25°) 4000°K	Lm (Output)	Sost.	Dimension
11	1618	1077	1x26W FL-C	D2

mod/VS

Offiche e diffusori

Riflettore in alluminio metallizzato, vetro sabbato.

Louvers and diffusers

Metallised aluminium reflector, c/ w sanded glass.

- 3000°K = -5.30% lm
- 4000°K = standard
- 5000°K = +0.90% lm

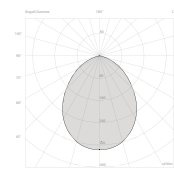

IP40 850° IK07



W-Tot.	Lm (Tc=25°) 4000°K	Lm (Output)	Sost.	Dimension
20	3299	2197	2x26W FL-C	D3
30	4038	2689	70W JM-MH	D3

mod/VS

Offiche e diffusori

Riflettore in alluminio metallizzato, vetro sabbato.

Louvers and diffusers

Metallised aluminium reflector, c/ w sanded glass.

- 3000°K = -5.30% lm
- 4000°K = standard
- 5000°K = +0.90% lm

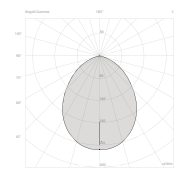

IP40 850° IK07



W-Tot.	Lm (Tc=25°) 4000°K	Lm (Output)	Sost.	Dimension
40	5867	3907	400W halog.	D4
55	8336	5551	500W halog.	D4