

PROFORMA

Specification Linear LED



Applications: Offices, education and healthcare, government, corporate, retail

PERFORMANCE SUMMARY

The Proforma Linear Series is a specification line of linear products, created with architects and lighting designers in mind. It offers a full linear lighting portfolio that's extremely versatile but very simple to design, configure and install.

Combining sleek seamless lines, brilliant color quality and ultra-smooth dimming, the Proforma Series is a modern solution designed to enhance both form and function.

Construction

- Nominal 2.75"W housing fabricated from heavy-gauge extruded aluminum
- Full linear portfolio of nominal 2'/4'/6'/8' lengths to design an entire space
- Interchangeable mounting detail for sheetrock or various tile grid ceilings
- Suspended installation employs aircraft cables that can be connected end to end with 6 different canopy options
- Sealed optical compartment rated for damp locations
- Gray, black or white trim colors complements every decor
- Textured polyester powdercoat with multi-stage matte finish
- Configurable for individual or continuous runs of up to 40' with 90° L/T/X and 120° joiners

Optical

- Shielding attachments provide reduced glare and added uniformity
- Multiple light output options for just the right amount of light
- Available in UGR<19 parabolic lens
- 5 CCTs 3000k to 3500k, 4000k, 4500k, 5000k
- 110° wide beam uplight distribution allows wider spacings

Electrical

- AC120-347V
- Enhanced ultra smooth dimming down to 5% compatible with most Lutron and Leviton 0-10V controllers
- Integrated sensor systems both in occupancy and daylight control
- Average rated life L80: >60,000H
- Operating Temperature: -13°F to 122°F
- SDCM: <5 UGR: <22 CRI: > 80

PERFORMANCE

Shape	300 Lumens Per Ft ¹			600 Lumens Per Ft ¹			900 Lumens Per Ft ¹		
	Wattage	Efficacy	Lumens	Wattage	Efficacy	Lumens	Wattage	Efficacy	Lumens
2' Linear	5.2	115	600	10.5	115	1,200	15	120	1,800
4' Linear	10.5	115	1,200	21	115	2,400	30	120	3,600
6' Linear	15.5	115	1,800	31.5	115	3,600	45	120	5,400
8' Linear	21	115	2,400	42	115	4,800	60	120	7,200
120° Joint	12	115	1,350	23.5	115	2,700	34	120	4,050
X Joint	13	115	1,500	26	115	3,000	38	120	4,500
T Joint	10.5	115	1,200	21	115	2,400	30	120	3,600
L Joint	10.5	115	1,200	21	115	2,400	30	120	3,600

¹Initial delivered lumens at 25°C (77°F). Actual production yield may vary between -10 and +10% of initial delivered

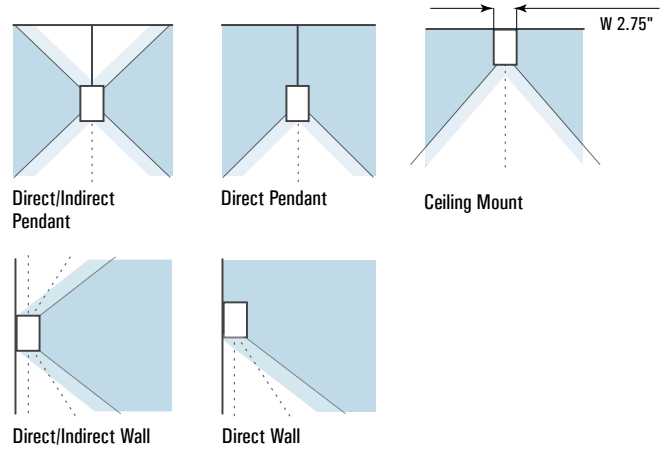

Shielding

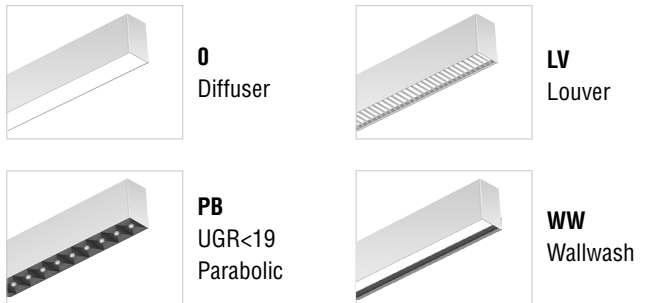

PROFORMA

Specification Linear LED

PRODUCT CODE

Example Proforma cat. 300.300.345.30.0.W.0.P.STL8.H.5.0.0.0

Model No	Length	Direct Output	Indirect Output	Direct CCT	Indirect CCT	Finish	Joints ¹
Proforma	2 - 2ft	300 - 300	300 - 300	345 - CCT	345 - CCT	G - Gray	LL - Lit
	4 - 4ft	Lumens Per Ft	Lumens Per Ft	Selectable	Selectable	B - Black	NL - Non Lit
	6 - 6ft	600 - 600	600 - 600	3/4/5000	3/4/5000	W - White	0 - None
	8 - 8ft	Lumens Per Ft	Lumens Per Ft	30 - 3500	30 - 3500		
		900 - 900	900 - 900	35 - 3500	35 - 3500		
		Lumens Per Ft	Lumens Per Ft	40 - 4000	40 - 4000		
	xxx - Custom	xxx - Custom	45 - 4500	45 - 4500			
	Lumens Per Ft	Lumens Per Ft	50 - 5000	50 - 5000			
		0 - None		0 - None			

Mounting	Pendant Kit	Ceiling	Canopy	Sensor	Emergency	Shielding	Accessories
C - Ceiling W - Wall	0 - None	0 - None	0 - None	M - Motion Sensor RC - Remote Control for Sensor 0 - None	EM - 8W/90min Emergency 0 - None	PB - Parabolic LV - Louver WW - Wallwash 0 - Diffuser	ACC - Acoustic Kit RL - 80ft Diffuser Lens 0 - None
P - Pendant	STL - 8' AC cord and Aircraft Cable Kit STLx - Custom Length AC Cord/Aircraft Cable Kit (Specify 'x')	T - T Grid H - Hard Ceiling	5 - 5" dia Round Canopy 0 - None	0 - None			

NOTES

¹For shape specification please provide diagram as directions on page 4

MOUNTING



C
Ceiling



P
Pendant

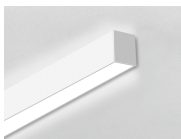

W
Wall Mounted



T
T Grid

ACCESSORIES

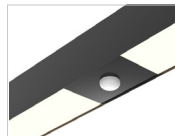

M
Motion Sensor



RL
80ft Diffuser Lens



ACC
Acoustic Kit

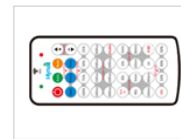

RC
Remote Control for Sensor

PROFORMA

Specification Linear LED

DIMENSIONS

Linear

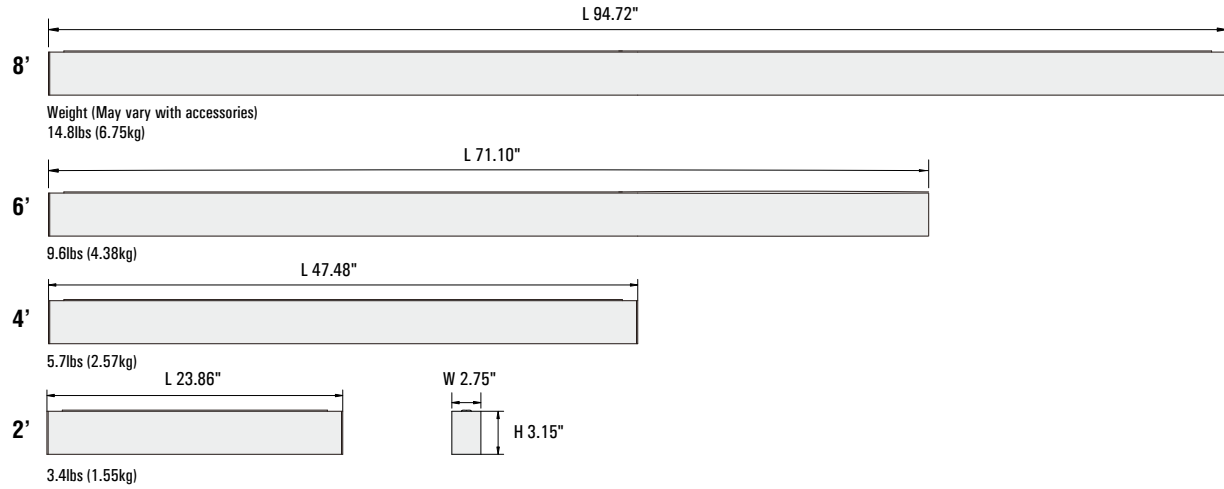

Lit

T-Joint

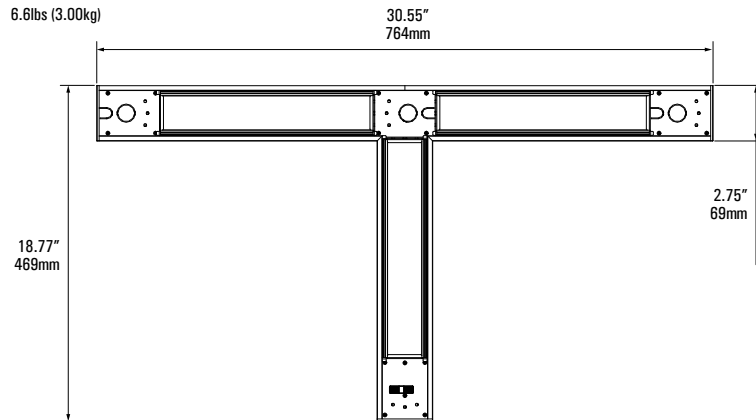

L-Joint

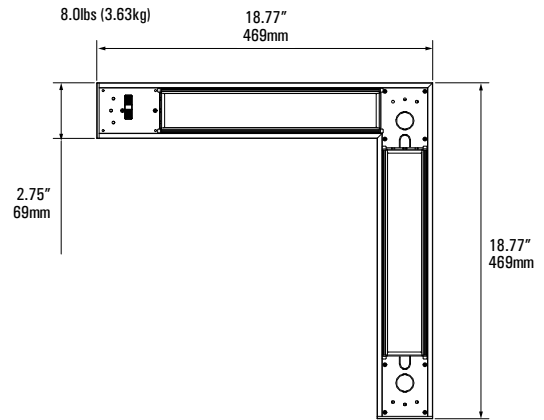

X-Joint

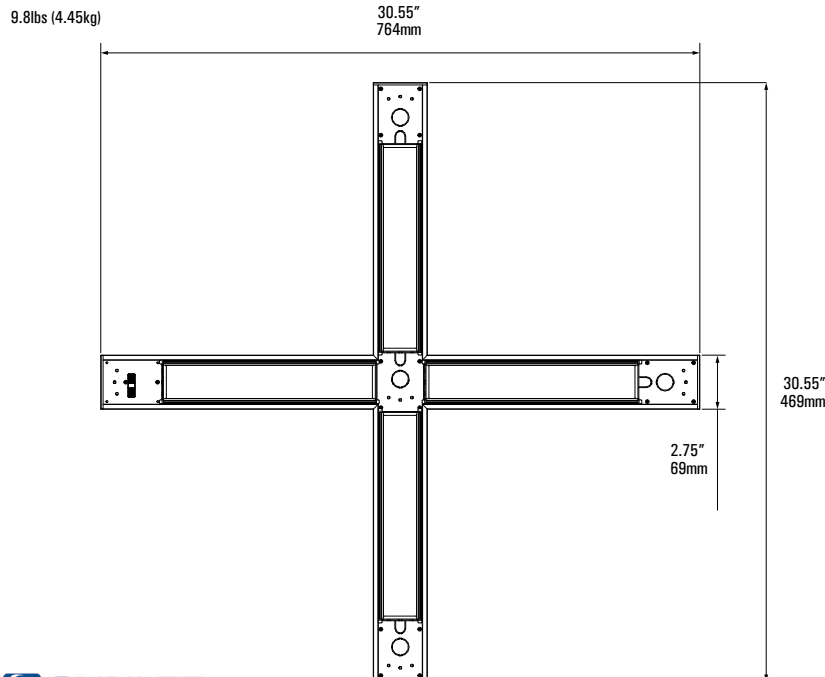

120° Joint

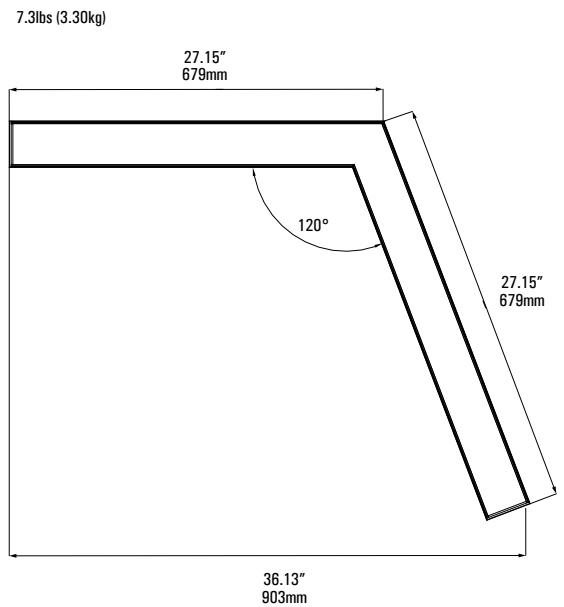

PROFORMA

Specification Linear LED

JOINTS

For shape please draw your layout sketch as below including linear lengths on all sides, part no and designated shape type, or consult factory for a detailed quotation

Shape Diagram

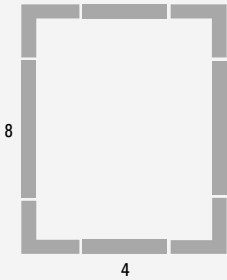

Eg. Proforma Type A
cat. x.300.300.30.45.G.LL.C.0

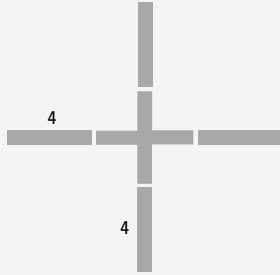

Eg. Proforma Type B
cat. x.300.300.30.45.B.LL.C.0

Lit

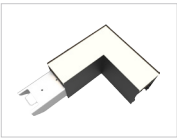

L
L Joint



T
T Joint



X
X Joint



120
120° Joint

Non-Lit



L
L Joint



X
X Joint



T
T Joint

LINKAGE

Single

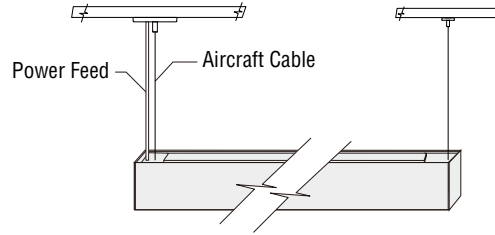

Continuous

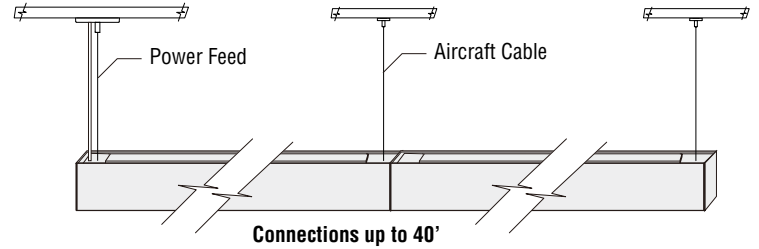

PHOTOMETRICS

110°

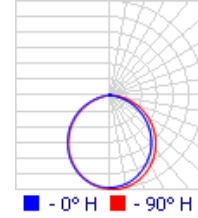
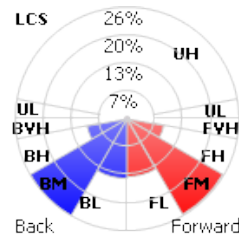

SENSOR COVERAGE

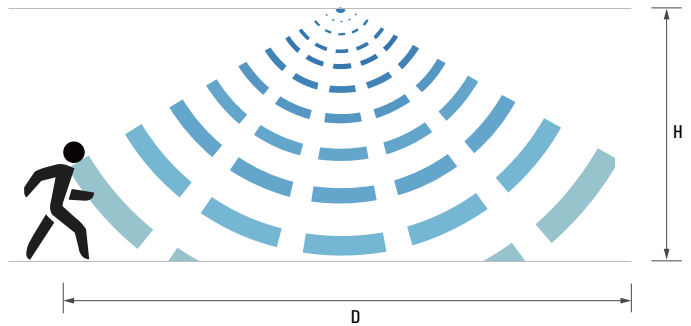

Mounting Height H (ft)	Sensor Coverage Dia D (ft)
10	20
12	26
14	28
20	38