

CONDOR HP

Parking Lot and Area Light



Applications: Parking lots, general area lighting, sporting facilities, roadway, car dealerships

PERFORMANCE SUMMARY

The Condor family is a specification defining outdoor lighting solution designed with high-level optics for maximum illumination aiding in reducing the number of poles. It's refined profile with sleek square geometric lines blends seamlessly into any environment

Every Condor area product can be fitted with multiple brackets and arms making an effortless one step installation in any application

Construction

- Aerodynamic shape with lower EPA reduces wind drag
- Finished in a polyester powdercoat process with 500hr salt spray treatment retaining color and gloss over time
- Tool less magnetic optical compartment enables easy field changeover or rotation of lens
- 4 in 1 universal bracket serves as an all-in-one solution for slipfitter, round or square pole direct mount or wall

Optical

- Available in 11 factory tunable outputs
- Engineered optics designed to achieve optimal uniformity by keeping consistent 4Fc over 1600sqft area
- Rotatable 90 and 180° left or right lens
- High transparency optics with light transmittance of up to 90% reducing light wastage and heat dissipation
- SDCM < 7

Electrical

- 100-277VAC, 200-480VAC
- Average rated life L90: >50,000H @ 95°F
- PF: > 0.90 THD: <20%
- Operating Temperature: -40°F to 113°F
- 10kV/10kA, UL 1449 fused surge protection as standard
- Premium driver featuring input surge, output over-voltage, short circuit and over temperature protection
- NEMA 3, 5 or 7 pin photocell receptable option
- Standard 0-10V dimming

PRODUCT CODE

Example Condor HP cat. 100.8L.T2.40.BR.UNV.0

Model No	Voltage	Wattage (W)	Distribution	CCT (°K)	Finish	Mounting	Sensor	
Condor HP	100	8L - 8,000 lms	38L - 38,400 lms	T2 - Type 2	30 - 3000K	BR - Bronze	SF - Slipfitter	PE1 - NEMA 3-Pin Photocell
	100-277V	10L - 10,400 lms	48L - 48,000 lms	T3 - Type 3	40 - 4000K	BK - Black	DM - Direct Round/Square Mount	PE2 - NEMA 5-Pin Photocell
	200	12L - 12,800 lms	64L - 64,000 lms	T4 - Type 4	50 - 5000K		UNV - Universal 4 in 1 Round or Square Bracket	PE3 - NEMA 7-Pin Photocell
	200-480V	16L - 16,000 lms	80L - 80,000 lms	T5 - Type 5			YK - Yoke	PIR - PIR Sensor
		19L - 19,200 lms	xxL ¹ - Custom	+ES - External Glare Shield			TR - Trunnion	0 - None
	24L - 24,000 lms		+EV - External 360° Full Visor					
	32L - 32,000 lms		+RR - Rotatable Optics					

NOTES

¹Maximum tunable to 80L



Specification	
Lumen Package	7,680 - 81,600
Wattage Range	50 - 500
Efficacy	154-163
Weight lbs (kg)	7.2 (3.3) - 14.10 (6.4)

Type II

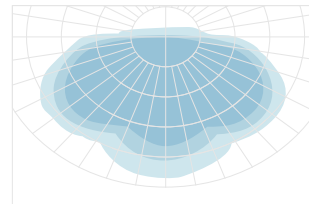

Type III

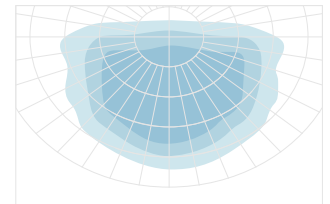

Type IV

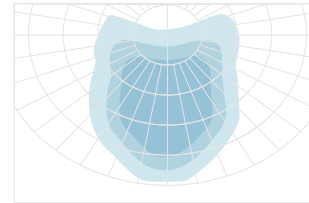

Type V

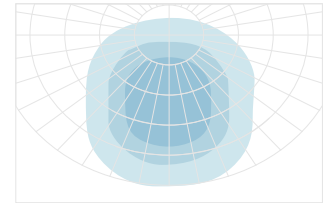

CONDOR HP







Parking Lot and Area Light

LUMEN OUTPUT

Lumen Package	System Watts	3000K		4000K		5000K	
		Lumens ¹	Efficacy LPW	Lumens ¹	Efficacy LPW	Lumens ¹	Efficacy LPW
8L	50	7,680	154	8,000	160	8,160	163
10L	65	9,984	154	10,400	160	10,608	163
12L	80	12,288	154	12,800	160	13,056	163
16L	100	15,360	154	16,000	160	16,320	163
19L	120	18,432	154	19,200	160	19,584	163
24L	150	23,040	154	24,000	160	24,480	163
32L	200	30,720	154	32,000	160	32,640	163
38L	240	36,864	154	38,400	160	39,168	163
48L	300	46,080	154	48,000	160	48,960	163
64L	400	61,440	154	64,000	160	65,280	163
80L	500	76,800	154	80,000	160	81,600	163

¹Initial delivered lumens at 25°C (77°F). Actual production yield may vary between -10 and +10% of initial delivered

EPA

Fixture Quantity & Mounting Configuration	Single	2 @ 180°	2 @ 90°	3 @ 90°	3 @ 120°	4 @ 90°
Mounting Type						
Up to 32L with DM	1.54	3.08	2.68	3.50	3.33	3.51
38L-48L with DM	1.95	3.90	3.39	4.43	4.21	4.45
64L-80L with DM	2.93	5.86	5.10	6.65	6.33	6.68
Up to 32L with SL	1.72	3.45	3.00	3.92	3.73	3.93
38L-48L with SL	2.18	4.37	3.80	4.96	4.72	4.98
64L-80L with SL	3.28	6.56	5.71	7.45	7.09	7.48

¹Including luminaire head and mounting arm as shown. Contact factor for other tenons, arms or bracket EPA data

ROTATABLE OPTICS

Standard

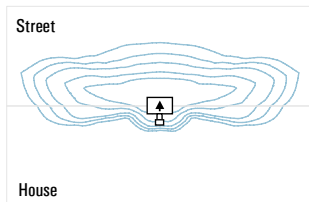

Left at 90°

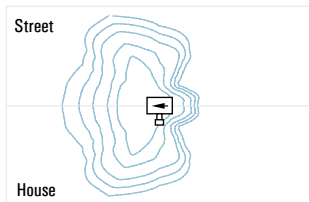

Right at 90°

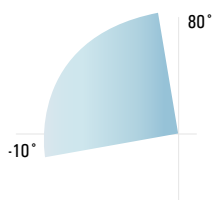
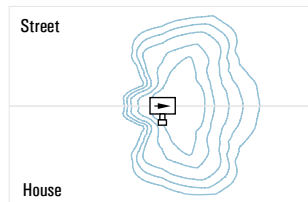

Adjustable Tilt Angle

- Available on SF, DM and UNV brackets
- Tilt increments of 5°
- Can be up/down aiming orientation



CONDOR HP

Parking Lot and Area Light

DIMENSIONS

64-80L

Weight (May vary with accessories)
14.23lbs/6.91kg

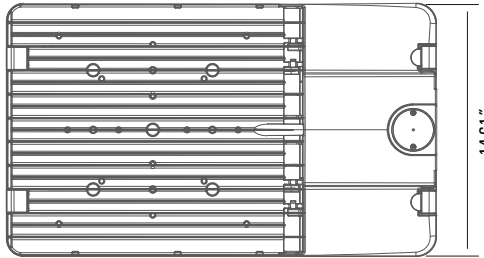
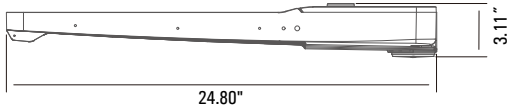

38-48L

Weight: 9.79lbs/4.44kg

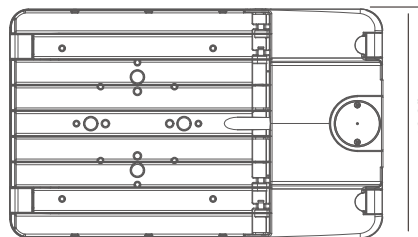
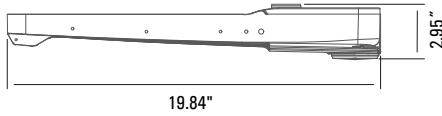

Up to 32L

Weight: 8.29lbs/3.76kg

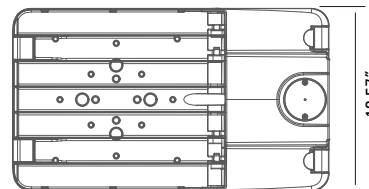
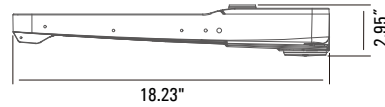

OPTIONS

Mounting

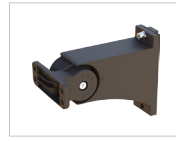

SP
Direct Square
Pole



UNV
Universal
4 in 1 Bracket



SF
Slipfitter



TR
Trunnion



YK
Yoke

Accessories



ES
External
Glare Shield



EV
External 360°
Full Visor

COVERAGE PATTERN

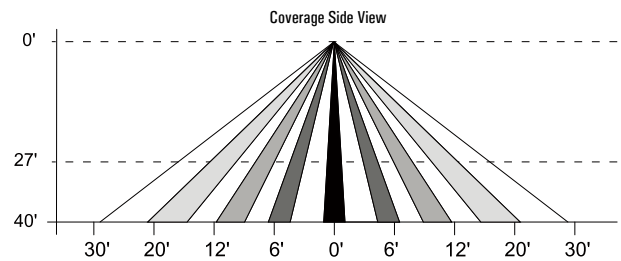
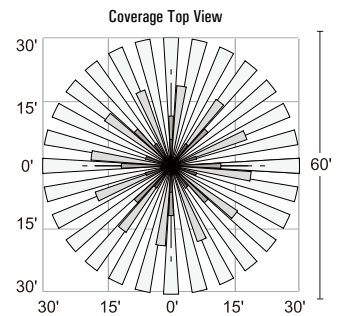
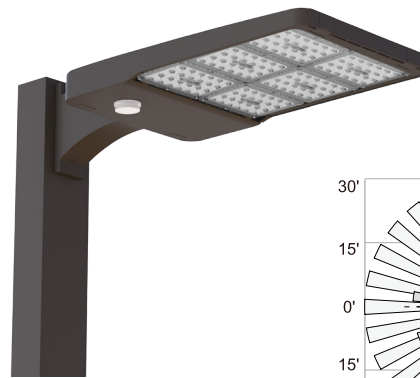

CONDOR HP

Parking Lot and Area Light

DRILL PATTERN

DM Direct Mount (16-48L)

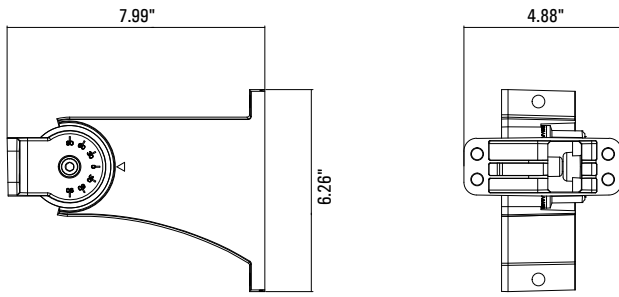

DM Direct Mount (64-80L)

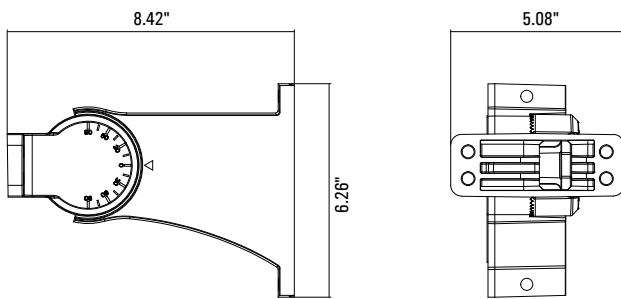

SF Slipfitter (16-48L)

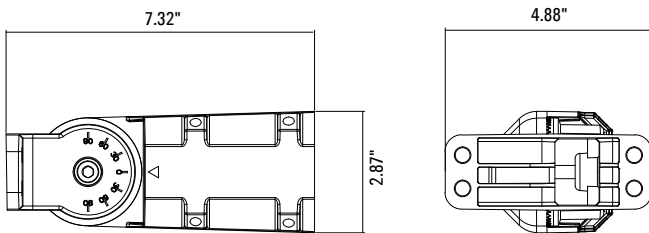

SF Slipfitter (64-80L)

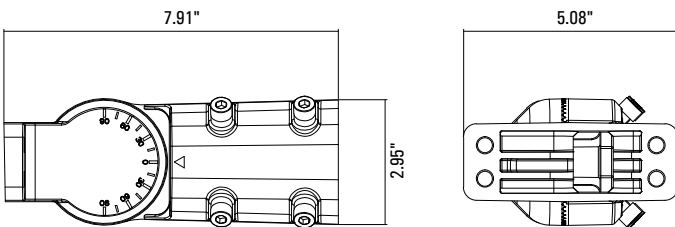

UNV Universal Bracket (16-48L)

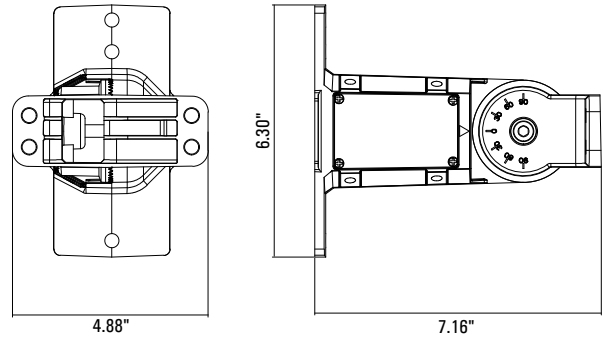

UNV Universal Bracket (64-80L)

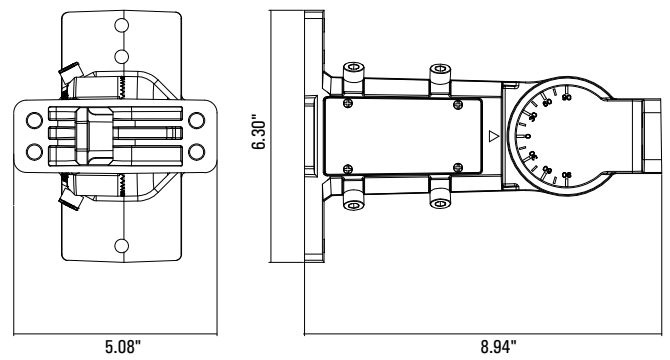

TR Trunnion

